



SEMIPONT® 3

Power Bridge Rectifiers

SKB 72

Features

- Robust plastic case with screw terminals
- Large, isolated base plate
- Blocking voltage up to 1800 V
- High surge currents
- Single phase bridge rectifier
- Easy chassis mounting
- UL recognized, file no. E 63 532

Typical Applications*

- Single phase rectifiers for power supplies
- Input rectifiers for variable frequency drives
- Rectifiers for DC motor field supplies
- Battery charger rectifiers

1) Freely suspended or mounted on an isolator
 2) Mounted on a painted metal sheet of min. 250 x 250 x 1 mm;
 $R_{th(s-a)} = 1,8 \text{ K/W}$

| V_{RSM} V | V_{RRM}, V_{DRM} V | $I_D = 70 \text{ A}$ (full conduction) ($T_c = 101 \text{ }^\circ\text{C}$) |
|----------------|-------------------------|--|
| 400 | 400 | SKB 72/04 |
| 800 | 800 | SKB 72/08 |
| 1200 | 1200 | SKB 72/12 |
| 1400 | 1400 | SKB 72/14 |
| 1600 | 1600 | SKB 72/16 |
| 1800 | 1800 | SKB 72/18 |

| Symbol | Conditions | Values | Units |
|---------------|--|---------------|------------------|
| I_D | $T_c = 85 \text{ }^\circ\text{C}$ resistive / inductive load | 86 | A |
| | $T_a = 45 \text{ }^\circ\text{C}$; isolated ¹⁾ | 10 | A |
| | $T_a = 45 \text{ }^\circ\text{C}$; chassis ²⁾ | 23,5 | A |
| | $T_a = 45 \text{ }^\circ\text{C}$; P1A/120 (P1A/200) | 48 (54) | A |
| I_{FSM} | $T_{vj} = 25 \text{ }^\circ\text{C}$; 10 ms | 750 | A |
| | $T_{vj} = 150 \text{ }^\circ\text{C}$; 10 ms | 640 | A |
| i^2t | $T_{vj} = 25 \text{ }^\circ\text{C}$; 8,3 ... 10 ms ms | 2800 | A ² s |
| | $T_{vj} = 150 \text{ }^\circ\text{C}$; 8,3 ... 10 ms ms | 2000 | A ² s |
| V_F | $T_{vj} = 25 \text{ }^\circ\text{C}$; $I_F = 150 \text{ A}$ | max. 1,6 | V |
| $V_{(TO)}$ | $T_{vj} = 150 \text{ }^\circ\text{C}$ | max. 0,85 | V |
| r_T | $T_{vj} = 150 \text{ }^\circ\text{C}$ | max. 5 | mΩ |
| I_{RD} | $T_{vj} = 25 \text{ }^\circ\text{C}$; $V_{DD} = V_{DRM}$; $V_{RD} = V_{RRM}$ | max. 0,5 | mA |
| | $T_{vj} = 150 \text{ }^\circ\text{C}$; $V_{RD} = V_{RRM}$ | 6 | mA |
| $R_{th(j-c)}$ | per diode | 1,1 | K/W |
| | total | 0,275 | K/W |
| $R_{th(c-s)}$ | total | 0,07 | K/W |
| | | | |
| T_{vj} | | -40 ... + 150 | $^\circ\text{C}$ |
| T_{stg} | | -40 ... + 125 | $^\circ\text{C}$ |
| V_{isol} | a. c. 50 Hz; r.m.s.; 1 s / 1 min. | 3600 (3000) | V |
| M_s | to heatsink | $5 \pm 15\%$ | Nm |
| M_t | to terminals | $5 \pm 15\%$ | Nm |
| m | | 165 | g |
| Case | | G 35 | |

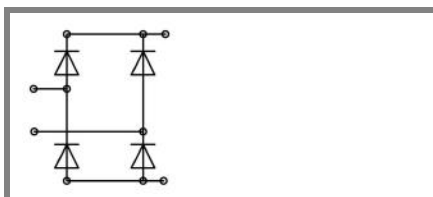

SKB

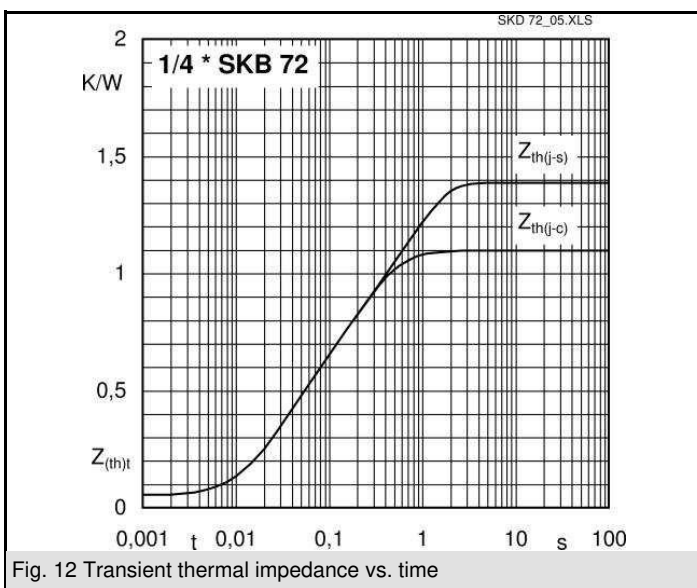
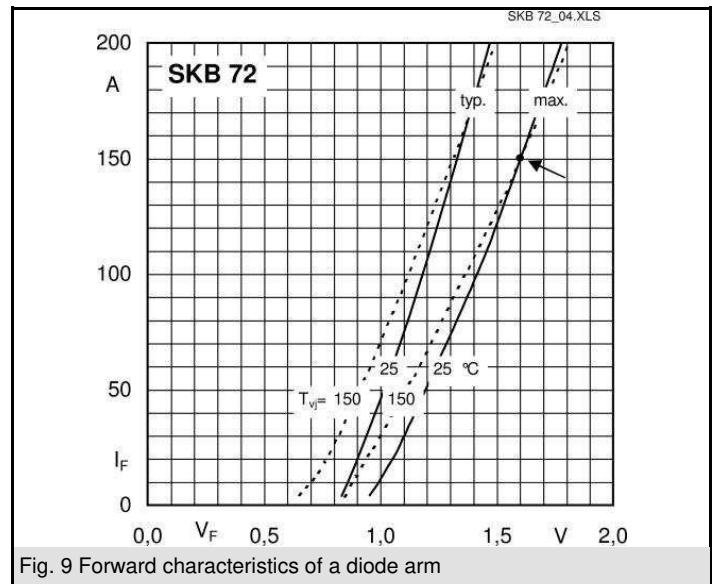
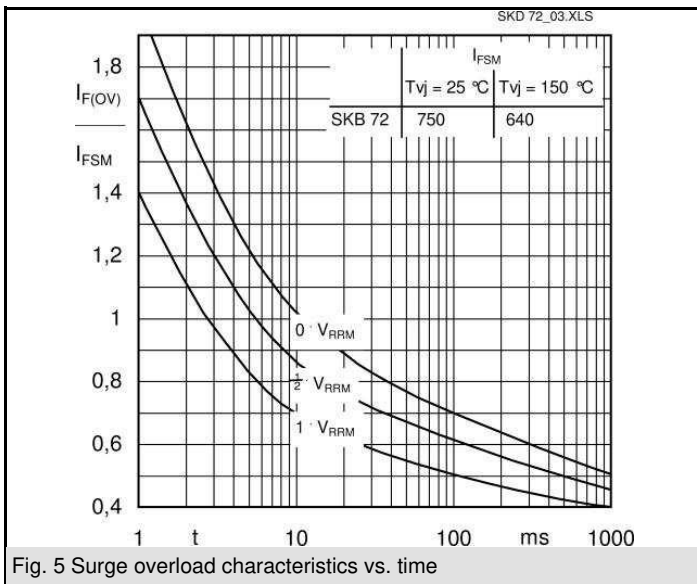
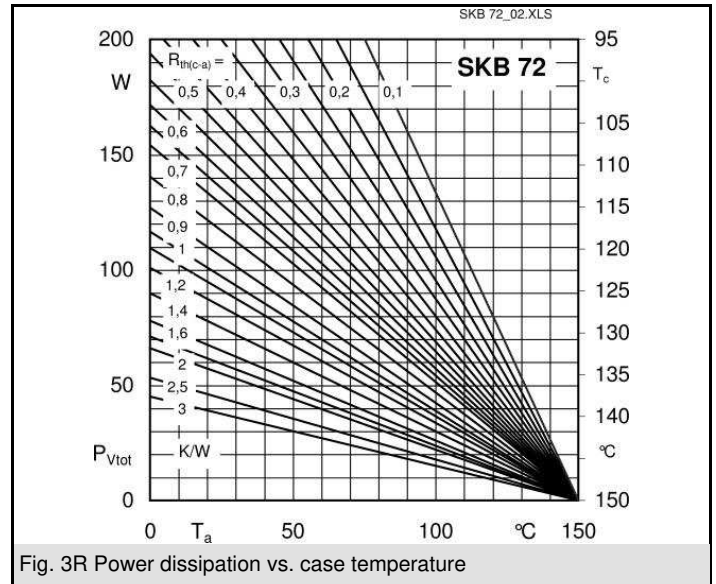
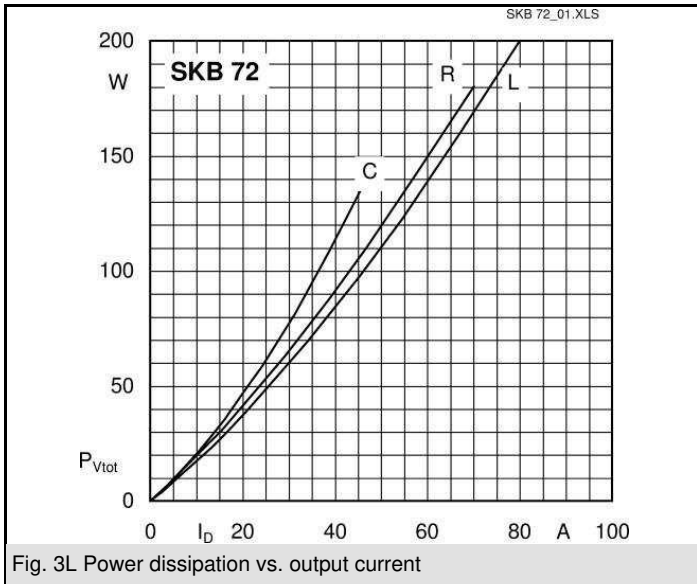

Dimensions in mm

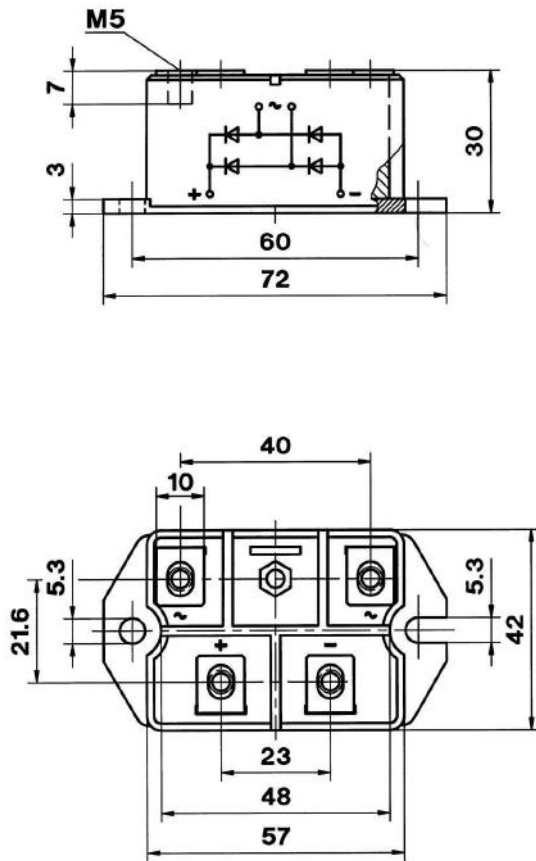

Case G 35

* The specifications of our components may not be considered as an assurance of component characteristics. Components have to be tested for the respective application. Adjustments may be necessary. The use of SEMIKRON products in life support appliances and systems is subject to prior specification and written approval by SEMIKRON. We therefore strongly recommend prior consultation of our personal.