

SKN 400, SKR 400

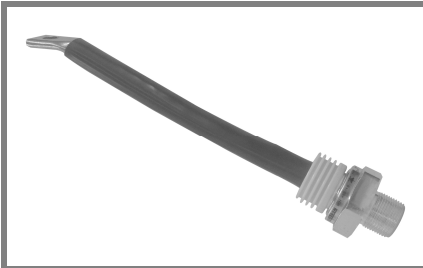

Stud Diode

V_{RSM} V	V_{RRM} V	$I_{FRMS} = 700$ A (maximum value for continuous operation) $I_{FAV} = 400$ A (sin. 180; $T_c = 100$ °C)	
1800	1800	SKN 400/18	SKR 400/18
2000	2000	SKN 400/20	SKR 400/20
2400	2400	SKN 400/24	SKR 400/24
2700	2700	SKN 400/27	SKR 400/27
3000	3000	SKN 400/30	SKR 400/30
3600	3600	SKN 400/36	SKR 400/36

Rectifier Diode

SKN 400
SKR 400

Features

- Reverse voltages up to 3600 V
- Hermetic metal cases with glass insulator
- Threaded stud M24 x 1,5 mm.
- **SKN**: anode to stud
- **SKR**: cathode to stud

Typical Applications *

- High voltage rectifier diode, especially for traction applications
- Cooling via heatsinks
- Non-controllable and half-controllable rectifiers
- Free-wheeling diodes
- Recommended snubber network:
RC: 1,0 μ F, 20 Ω ($P_R = 5$ W),
 R_p : 25 K Ω ($P_R = 20$ W)

Symbol	Condition	Values	Units
I_{FAV}	sin. 180 ; $T_c = 85$ (100) °C	445 (400)	A
I_D	K 0,55; $T_a = 45$ °C; B2 / B6 K 0,55F; $T_a = 35$ °C; B2 / B6	310 / 450 700 / 1000	A A
I_{FSM}	$T_{vj} = 25^\circ$ C ; 10 ms $T_{vj} = 160^\circ$ C ; 10 ms	9000 7500	A A
i^2t	$T_{vj} = 25^\circ$ C ; 8,3...10 ms $T_{vj} = 160^\circ$ C ; 8,3...10 ms	400000 280000	A ² s A ² s
V_F	$T_{vj} = 25^\circ$ C, $I_F = 1200$ A	max. 1,45	V
$V_{(TO)}$	$T_{vj} = 160^\circ$ C	max. 0,9	V
r_T	$T_{vj} = 160^\circ$ C	max. 0,5	m Ω
I_{RD}	$T_{vj} = 160^\circ$ C ; $V_R = V_{RRM}$	max. 60	mA
Q_{rr}	$T_{vj} = 160^\circ$ C, $-di_F/dt = 10$ A/ μ s	typ. 400	μ C
$R_{th(j-c)}$		0,11	K/W
$R_{th(c-s)}$		0,01	K/W
T_{vj}		-40...+160	°C
T_{stg}		-55...+160	°C
V_{isol}		-	V~
M_s	to heatsink (SI units) to heatsink (US units)	60 531	Nm lb.in.
a		5 * 9,81	m/s ²
m	approx.	500	g
Case		E 17	



SKN



SKR

SKN 400, SKR 400

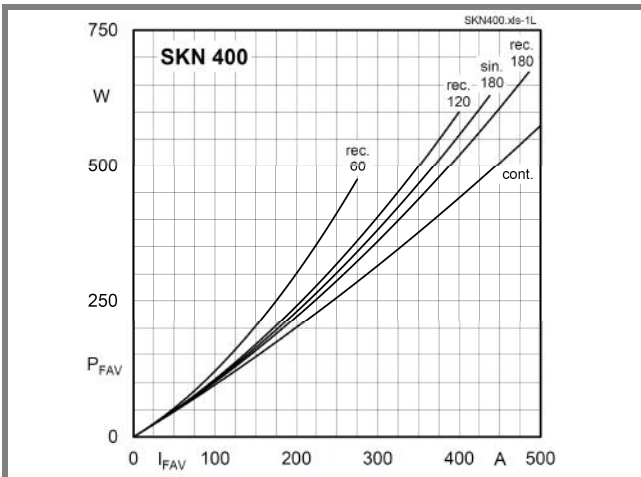

Fig. 1L Power dissipation vs. forward current

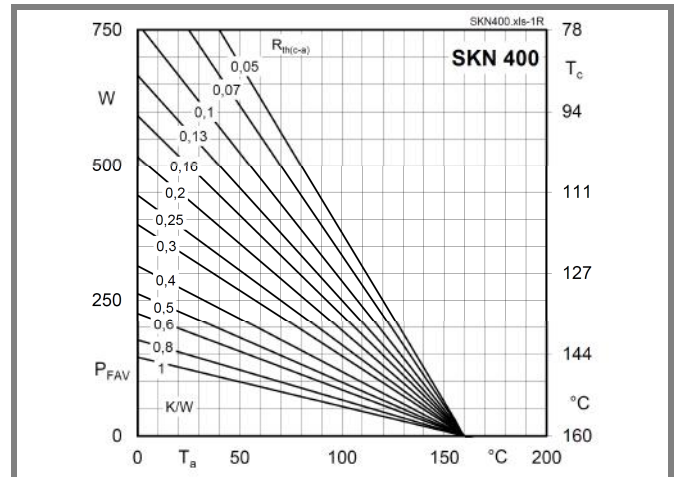

Fig. 1R Power dissipation vs. ambient temperature

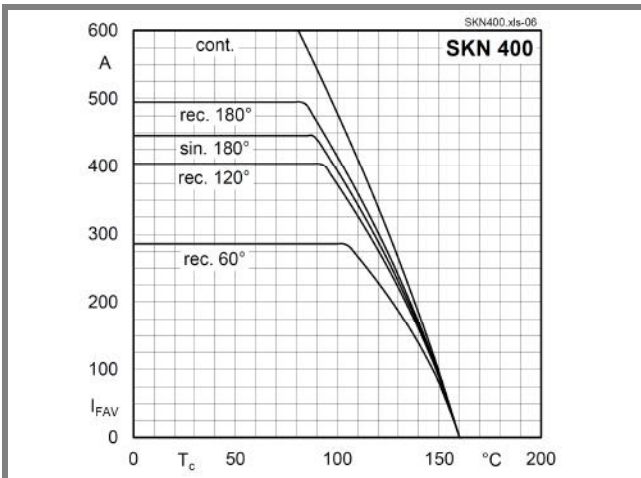

Fig. 2 Forward current vs. case temperature

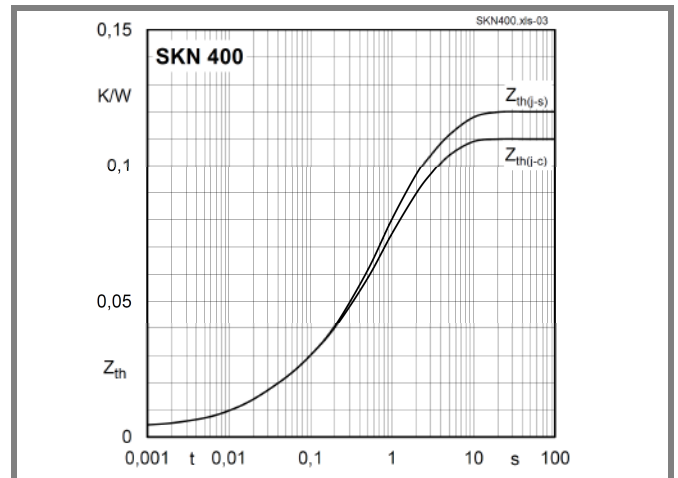

Fig. 4 Transient thermal impedance vs. time

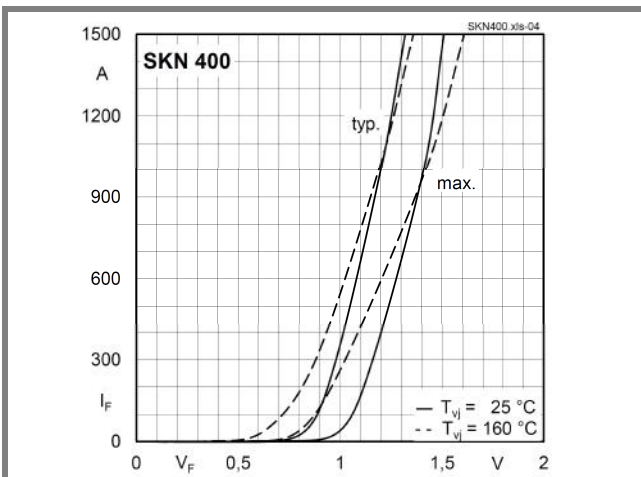

Fig. 5 Forward characteristics

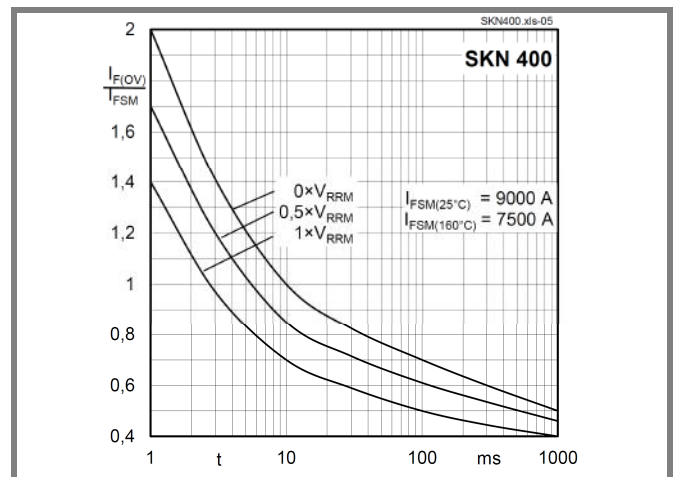
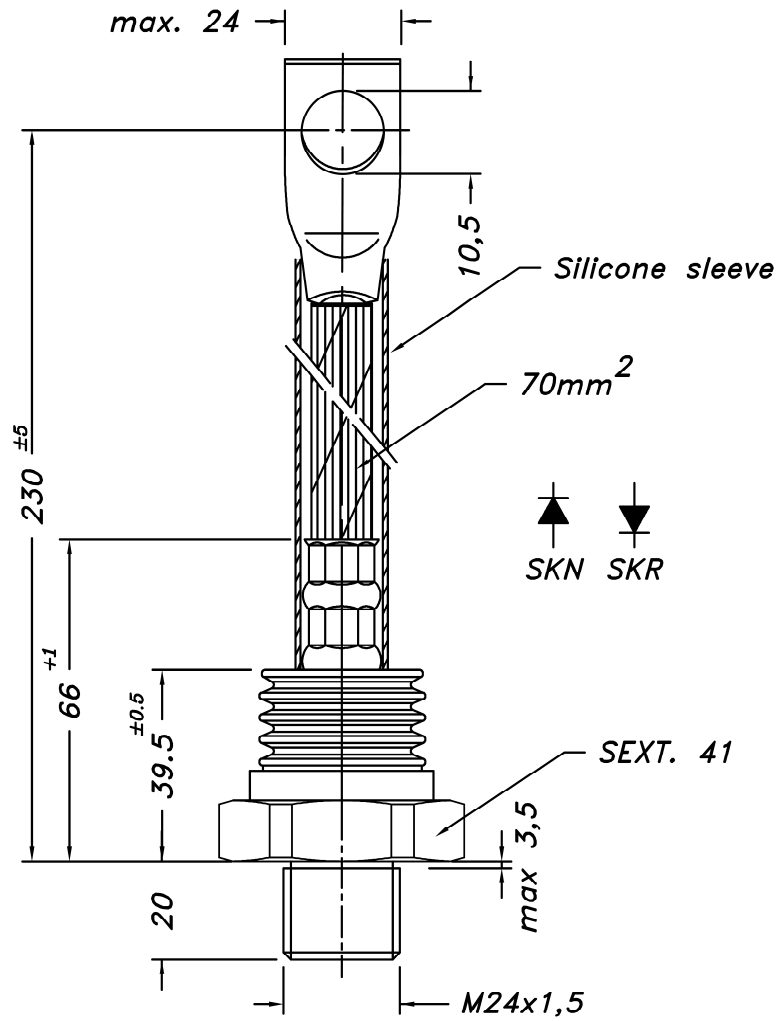

Fig. 6 Surge overload current vs. time



Case E17 (IEC 60191: A 22 B)

* The specifications of our components may not be considered as an assurance of component characteristics. Components have to be tested for the respective application. Adjustments may be necessary. The use of SEMIKRON products in life support appliances and systems is subject to prior specification and written approval by SEMIKRON. We therefore strongly recommend prior consultation of our personal.