

V <sub>RSM</sub>	V <sub>RRM</sub>	(dv/dt) <sub>cr</sub>	I <sub>TRMS</sub> (maximum value for continuous operation)			
			180 A			
			I <sub>TAV</sub> (sin. 180; T <sub>case</sub> = 80 °C)			
V	V	V/μs	115 A			
500	400	500	–	–	SKKH 105/04 D	–
700	600	500	SKKT 105/06 D	SKKT 106/06 D	–	SKKH 106/06 D
900	800	500	SKKT 105/08 D	SKKT 106/08 D <sup>1)</sup>	SKKH 105/08 D	SKKH 106/08 D
1300	1200	1000	SKKT 105/12 E	SKKT 106/12 E <sup>1)</sup>	SKKH 105/12 E	SKKH 106/12 E
1500	1400	1000	SKKT 105/14 E	SKKT 106/14 E <sup>1)</sup>	SKKH 105/14 E	SKKH 106/14 E
1700	1600	1000	SKKT 105/16 E	SKKT 106/16 E <sup>1)</sup>	SKKH 105/16 E	SKKH 106/16 E
1900	1800	1000	SKKT 105/18 E	SKKT 106/18 E <sup>1)</sup>	SKKH 105/18 E	SKKH 106/18 E

## SEMIPACK® 1 Thyristor / Diode Modules

**SKKT 105**      **SKKH 105**  
**SKKT 106**      **SKKH 106**  
**SKKT 106B**



Symbol	Conditions	SKKT 105 SKKH 105	SKKT 106 SKKT 106B SKKH 106	Units
I <sub>TAV</sub>	sin. 180; T <sub>case</sub> = 85 °C	106		A
I <sub>D</sub>	B2/B6   T <sub>amb</sub> = 35 °C; P 3/180 F	145 / 180		A
		P 16/200 F		A
I <sub>RMS</sub>	W1/W3   T <sub>amb</sub> = 35 °C; P 3/180 F	200 / 3 x 140		A
I <sub>TSM</sub>	T <sub>vj</sub> = 25 °C; 10 ms	2 250		A
	T <sub>vj</sub> = 130 °C; 10 ms	1 900		A
i <sup>2</sup> t	T <sub>vj</sub> = 25 °C; 8,3 ... 10 ms	25 000		A <sup>2</sup> s
	T <sub>vj</sub> = 130 °C; 8,3 ... 10 ms	18 000		A <sup>2</sup> s
t <sub>gd</sub>	T <sub>vj</sub> = 25 °C; I <sub>G</sub> = 1 A			μs
	di <sub>G</sub> /dt = 1 A/μs	1		μs
t <sub>gr</sub>	V <sub>D</sub> = 0,67 · V <sub>DRM</sub>	2		μs
(di/dt) <sub>cr</sub>	T <sub>vj</sub> = 130 °C	150		A/μs
t <sub>q</sub>	T <sub>vj</sub> = 130 °C	typ. 100		μs
I <sub>H</sub>	T <sub>vj</sub> = 25 °C; typ./max.	150 / 250		mA
I <sub>L</sub>	T <sub>vj</sub> = 25 °C; R <sub>G</sub> = 33 Ω; typ./max.	300 / 600		mA
V <sub>T</sub>	T <sub>vj</sub> = 25 °C; I <sub>T</sub> = 300 A	max. 1,65		V
V <sub>T(TO)</sub>	T <sub>vj</sub> = 130 °C	0,9		V
r <sub>T</sub>	T <sub>vj</sub> = 130 °C	2		mΩ
I <sub>DD</sub> ; I <sub>RD</sub>	T <sub>vj</sub> = 130 °C; V <sub>RD</sub> = V <sub>RRM</sub> V <sub>DD</sub> = V <sub>DRM</sub>	max. 20		mA
V <sub>GT</sub>	T <sub>vj</sub> = 25 °C; d.c.	3		V
I <sub>GT</sub>	T <sub>vj</sub> = 25 °C; d.c.	150		mA
V <sub>GD</sub>	T <sub>vj</sub> = 130 °C; d.c.	0,25		V
I <sub>GD</sub>	T <sub>vj</sub> = 130 °C; d.c.	6		mA
R <sub>thjc</sub>	cont. } per thyristor / sin. 180 } per module rec. 120 }	0,28 / 0,14		°C/W
		0,30 / 0,15		°C/W
		0,32 / 0,16		°C/W
R <sub>thch</sub>		0,2 / 0,1		°C/W
T <sub>vj</sub>		– 40 ... + 130		°C
T <sub>stg</sub>		– 40 ... + 125		°C
V <sub>isol</sub>	a. c. 50 Hz; r.m.s.; 1 s/1 min	3600 / 3000		V~
M <sub>1</sub>	to heatsink } SI (US) units	5 (44 lb. in.) ± 15 % <sup>2)</sup>		Nm
M <sub>2</sub>	to terminals }	3 (26 lb. in.) ± 15 % <sup>2)</sup>		Nm
a		5 · 9,81		m/s <sup>2</sup>
w	approx.	95		g
Case	→ page B 1 – 95	SKKT 105: A 5 SKKH 105: A 6	SKKT 106: A 46 SKKT 106B: A 48 SKKH 106: A 47	



**SKKT 105**      **SKKH 105**



**SKKT 106**      **SKKH 106**  
**SKKT 106B**

### Features

- Heat transfer through aluminium oxide ceramic isolated metal baseplate
- Hard soldered joints for high reliability
- UL recognized, file no. E 63 532

### Typical Applications

- DC motor control (e.g. for machine tools)
- AC motor soft starters
- Temperature control (e.g. for ovens, chemical processes)
- Professional light dimming (studios, theaters)

<sup>1)</sup> Also available in SKKT 106 B configuration (case A 48)

<sup>2)</sup> See the assembly instructions

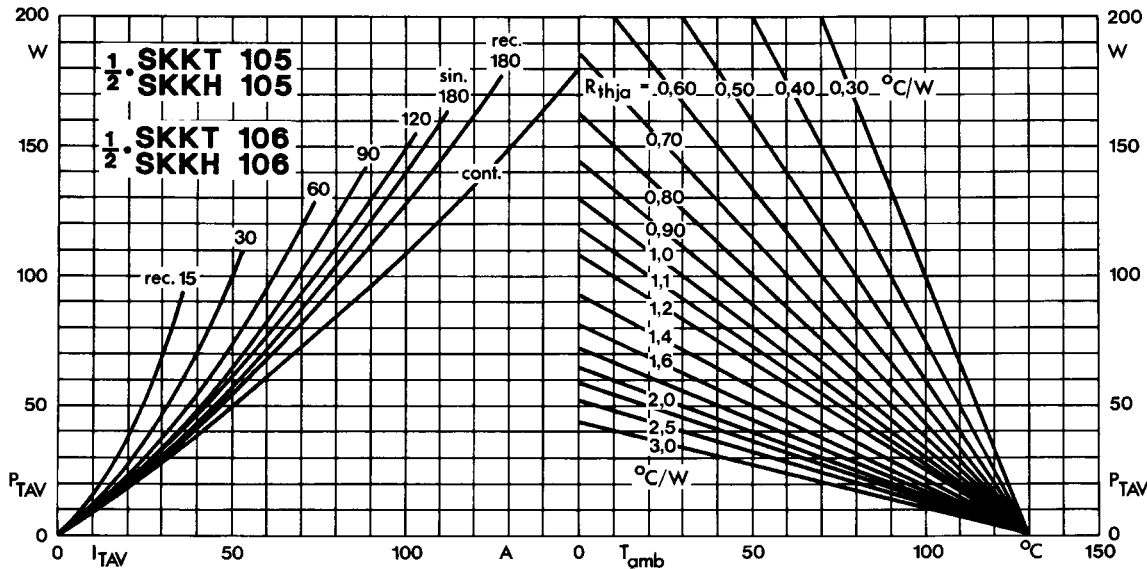

Fig. 1 Power dissipation per thyristor vs. on-state current and ambient temperature

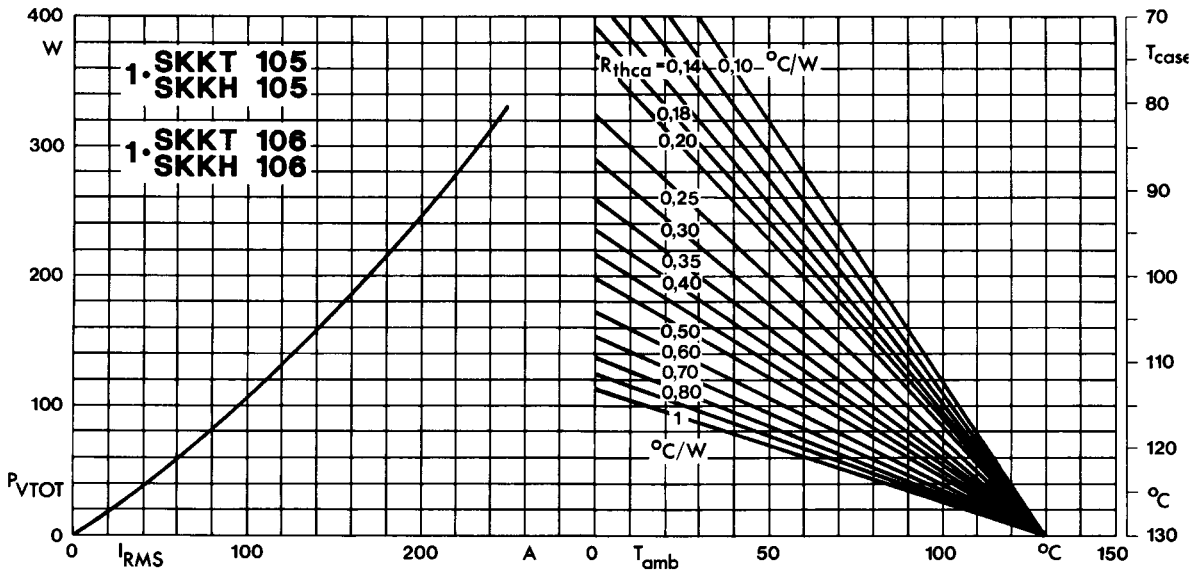

Fig. 2 Power dissipation per module vs. rms current and case temperature

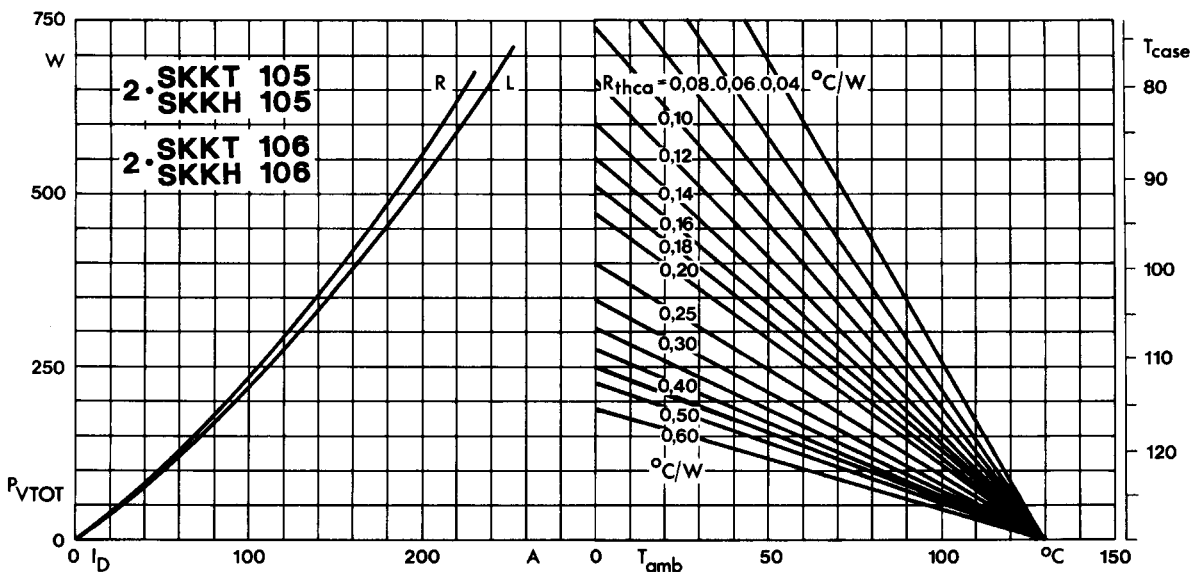

Fig. 3 Power dissipation of two modules vs. direct current and case temperature

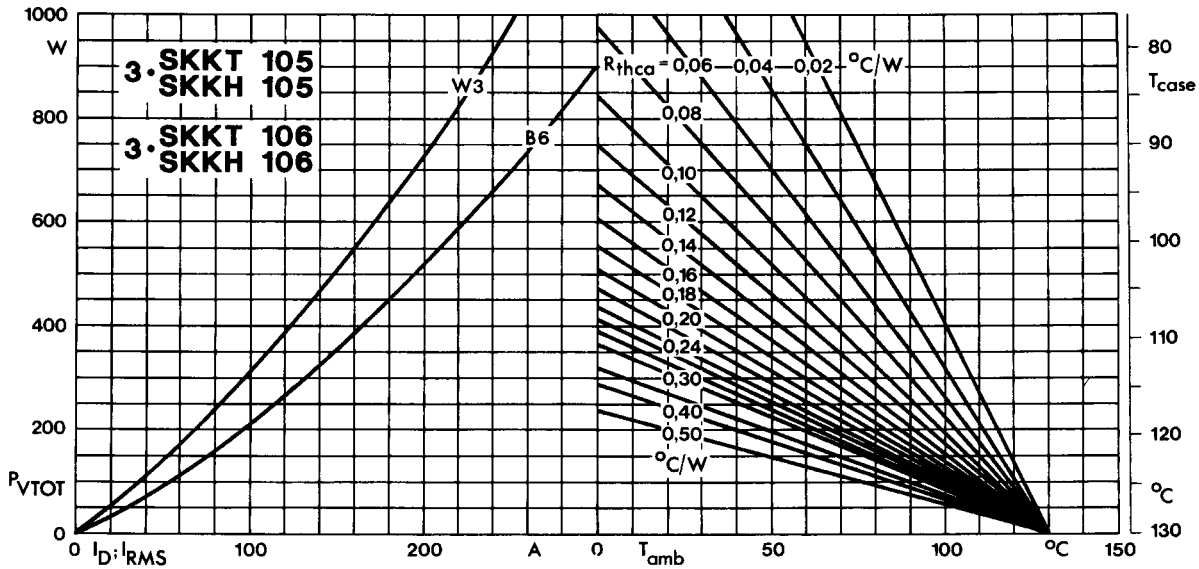

Fig. 4 Power dissipation of three modules vs. direct and rms current and case temperature

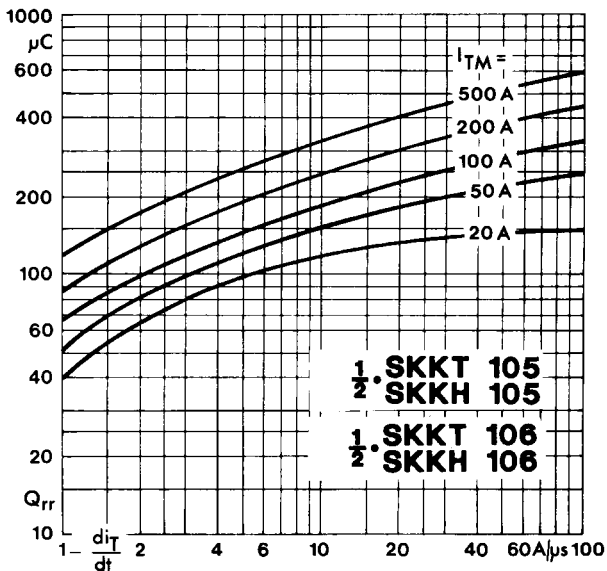

Fig. 5 Recovered charge vs. current decrease

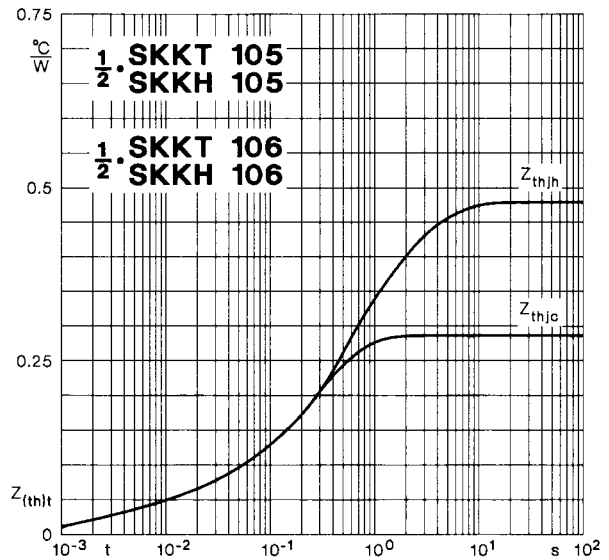

Fig. 6 Transient thermal impedance vs. time

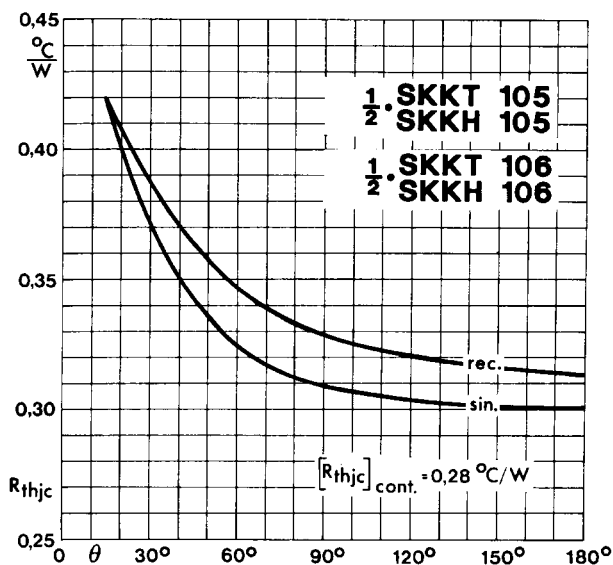

Fig. 7 Thermal resistance vs. conduction angle

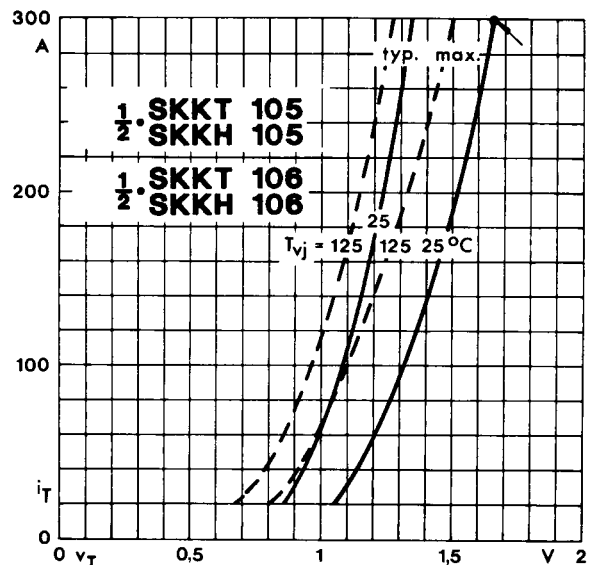

Fig. 8 On-state characteristics

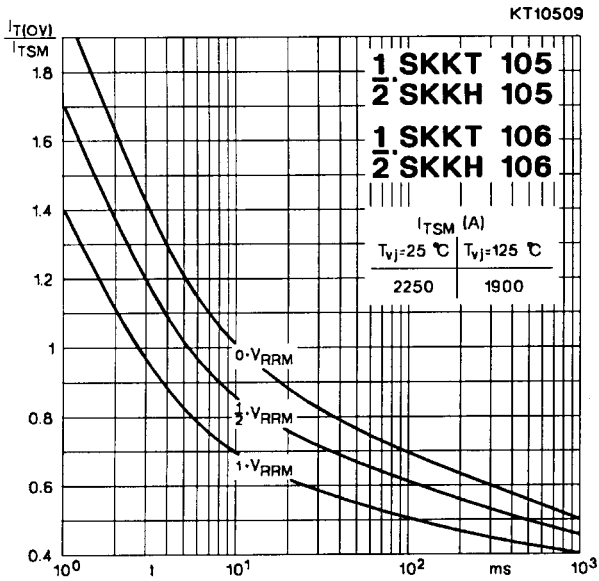

Fig. 9 Surge overload current vs. time

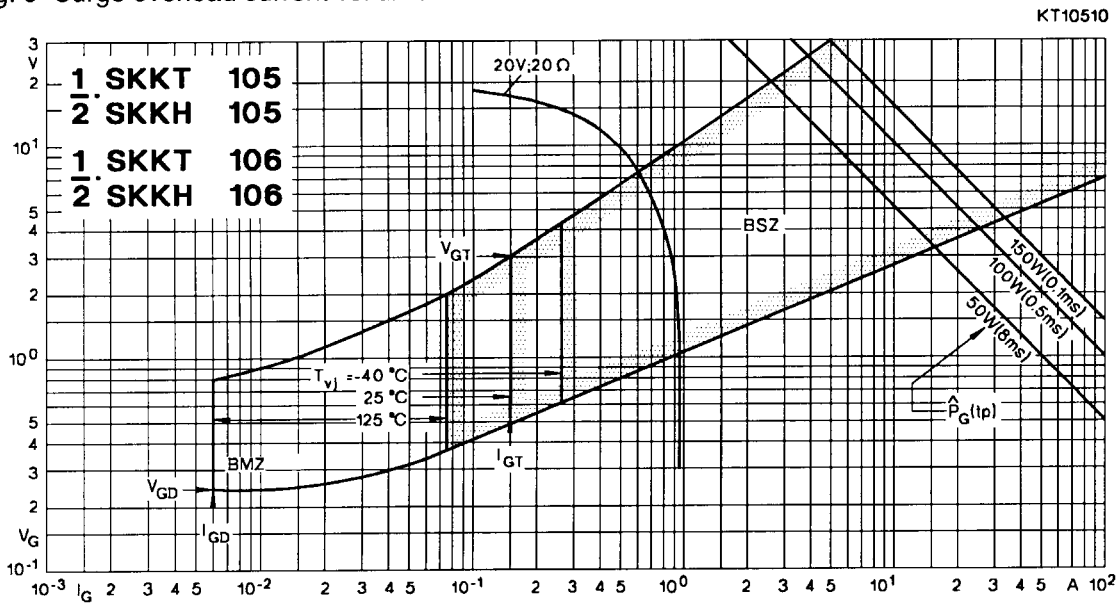

Fig. 10 Gate trigger characteristics

## SKKT 19 ... 105

Case A 5

IEC 192-2: A 77 A

JEDEC: TO-240 AA

SEMIPACK® 1

UL recognized, file no. E 63 532



Dimensions in mm

## SKKT 20/ ... 106/

Case A 46

IEC 192-2: A 77 A

JEDEC: TO-240 AA

SEMIPACK® 1

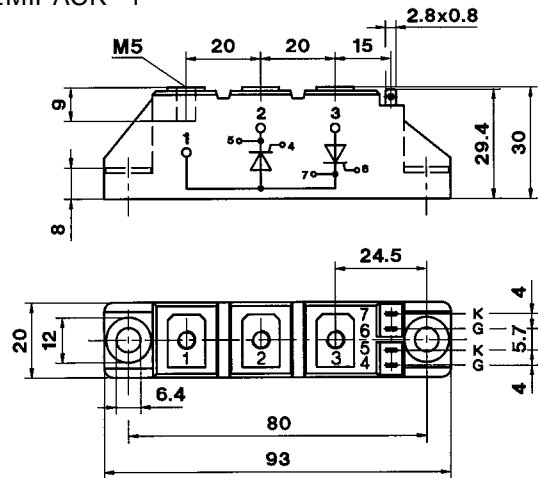

Dimensions in mm

## SKKH 26 ... 105

Case A 6

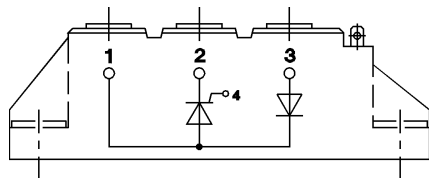

## SKKD 26 ... 100

Case A 10

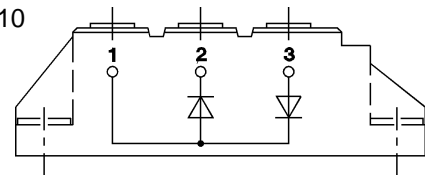

## SKNH 56 ... 91

Case A 7

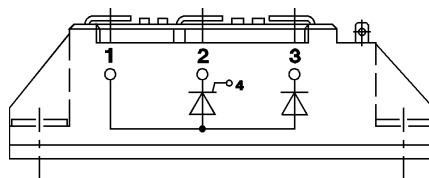

## SKKE 81

Case A 12

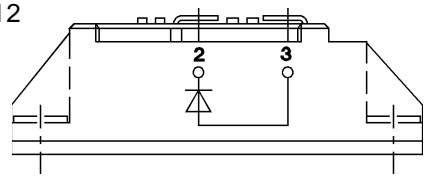

## SKKL 56 ... 105

Case A 9

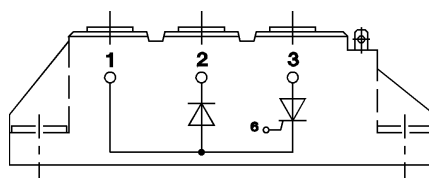

## SKKH 27 ... 106

Case A 47

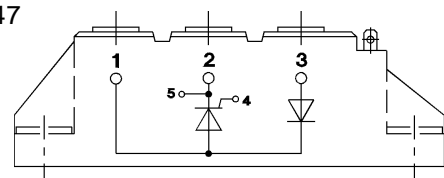

## SKND 46 ... 81

Case A 19

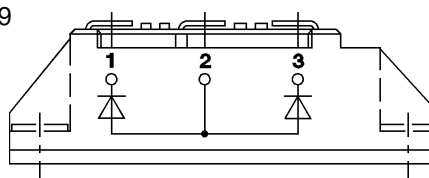

## SKKT 20 B ... 106 B

Case A 48

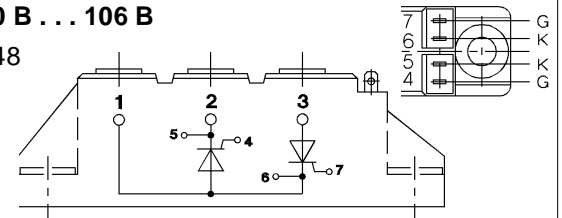

## SKMT 92

Case A 72

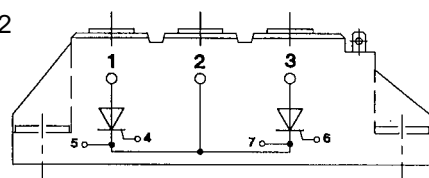

## SKKL 42 ... 106

Case A 59

